

ANNAPOLIS BRIDGE FAUCET / LEVER HANDLES / 2PC. SUITE

6200-2

- MAX COUNTER THICKNESS 2-3/8"
- MINIMUM INSTALL HOLE SIZE 1-3/8"

- A. Side Spray Connection with 1/4" NPT Pipe Fitting
- B. Supply Hoses - 20" Long with 3/8" Compression Fittings

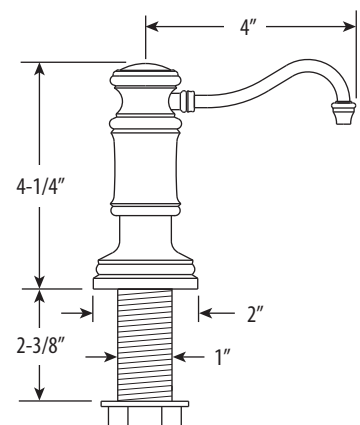
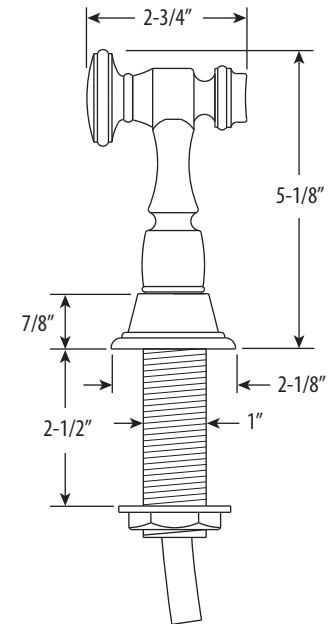
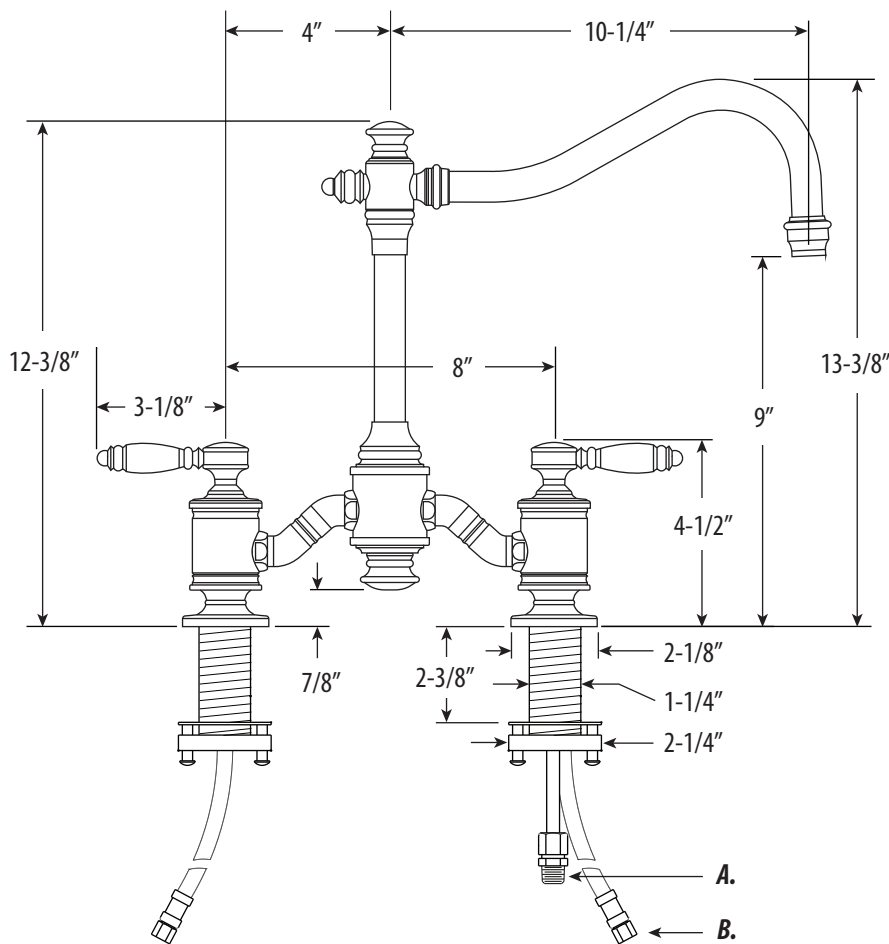

DIMENSIONS MAY VARY AND ARE SUBJECT TO CHANGE. NO RESPONSIBILITY IS ASSUMED FOR USE OF SUPERCEDED OR VOIDED DATA

