

## ENDEAVOR WHEEL PULLDOWN FAUCET / 4PC. SUITE

# 5130-4

- Max Counter Thickness 2-3/8"
- Minimum Install Hole Size 1-1/2"

A. Supply Hoses - 20" Long with 3/8" Compression Fittings

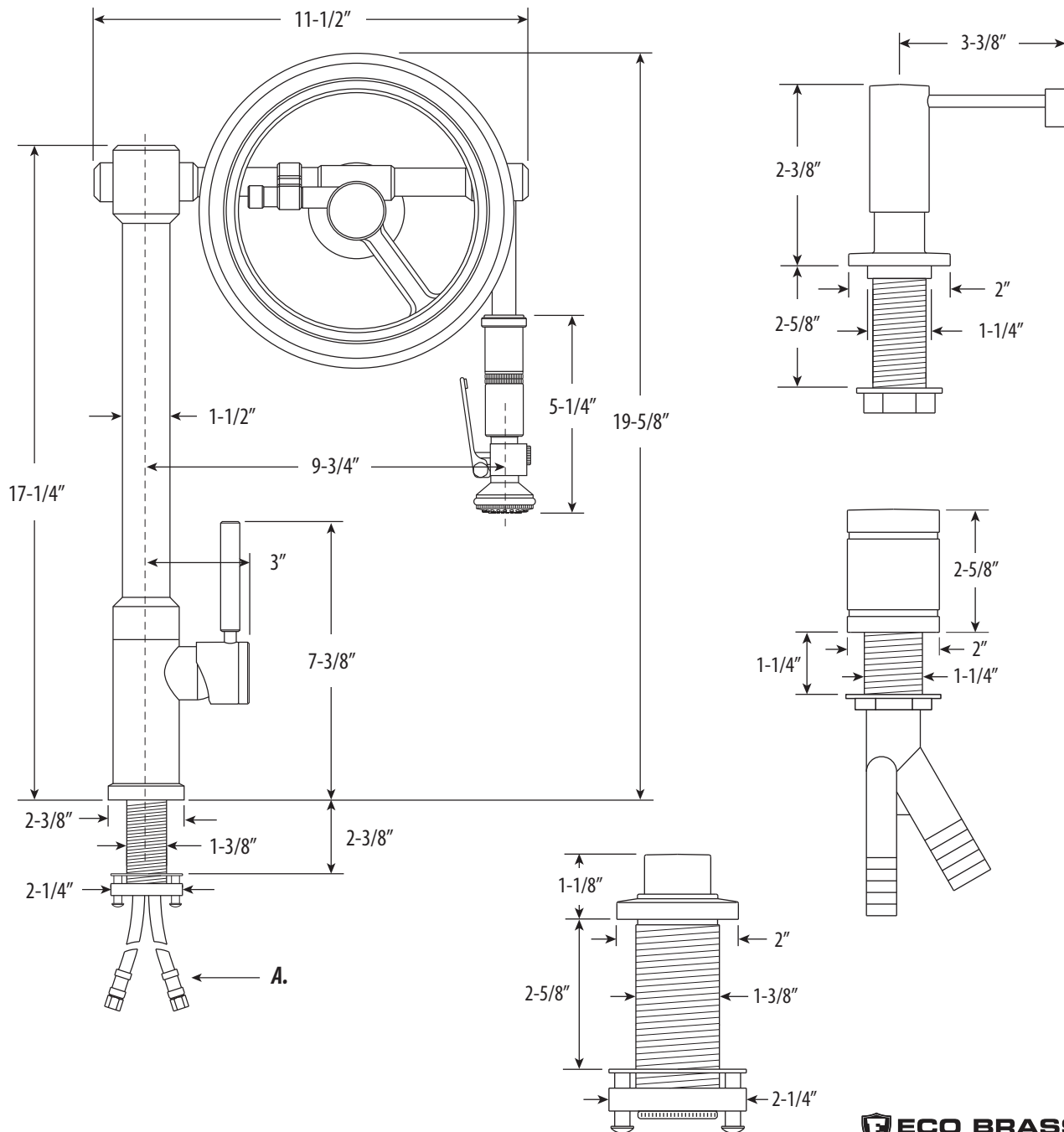

DIMENSIONS MAY VARY AND ARE SUBJECT TO CHANGE. NO RESPONSIBILITY IS ASSUMED FOR USE OF SUPERCEDED OR VOIDED DATA