

Commercial Wall-Hung Lavatory

FEATURES

- 20-7/8" x 18" lavatory with back splash
- Vitreous china
- ADA compliant
- Punching for concealed arm carrier
- Includes wall hanger
- Punching for concealed arm carriers
- Soap dispenser hole



MODELS

- LT307
Lavatory only, with single hole
- LT307.4
Lavatory only with 4" faucet centers
- LT307.8
Lavatory only with 8" faucet centers
- LT307A#01 (Cotton only)
Lavatory only with single hole. Left side soap hole

CODES/STANDARDS

- Meets and exceeds ASME A112.19.2/CSA B45.1,
- Certifications: IAPMO(cUPC), State of Massachusetts, City of Los Angeles, and others
- Meets ADA, TAS, ICC/ANSI A117.1 and CSA B651
- Code compliance: UPC, IPC, NSPC, NPC Canada, and others



COLORS/FINISHES

- Standard
#01 Cotton

PRODUCT SPECIFICATION

The lavatory shall be 20-7/8" width and 18" depth. The basin shall be 14-3/4" width by 10-1/8" depth. The lavatory shall be made of vitreous china and can be installed at ADA height with rear overflow. TOTO model number LT307A#01 shall be drilled for soap dispenser. Lavatory shall be TOTO model LT307_____.

LT307(A)

Commercial Wall-Hung Lavatory

SPECIFICATIONS

- Waste 1-1/4" O.D.
- Size 20-7/8"W x 18"D
- Warranty One Year Limited Warranty
- Material Vitreous china
- Shipping Weight 40 lbs.
- Shipping Dimensions 22-5/8"L x 19-1/8"W x 13-3/4"H

INSTALLATION NOTES

TOTO recommends the use of Jay R. Smith 0700 (Concealed Arms) with 19" arms 0800 (Wall Support Plate).

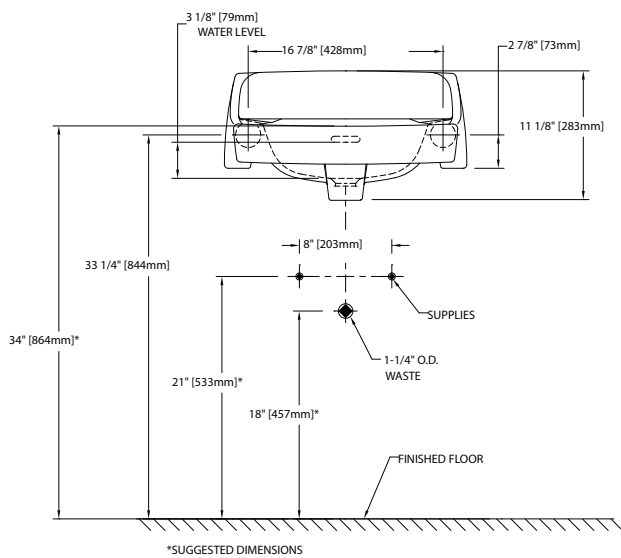
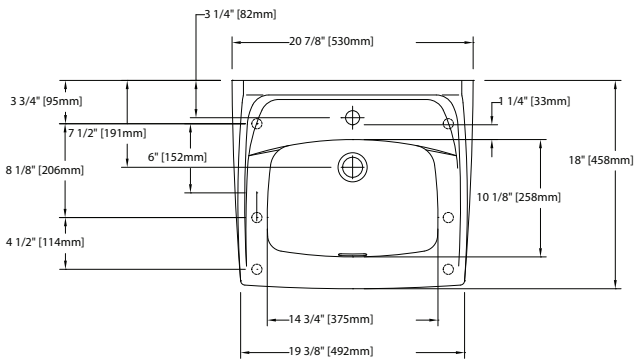

ADA COMPLIANCE CHECK

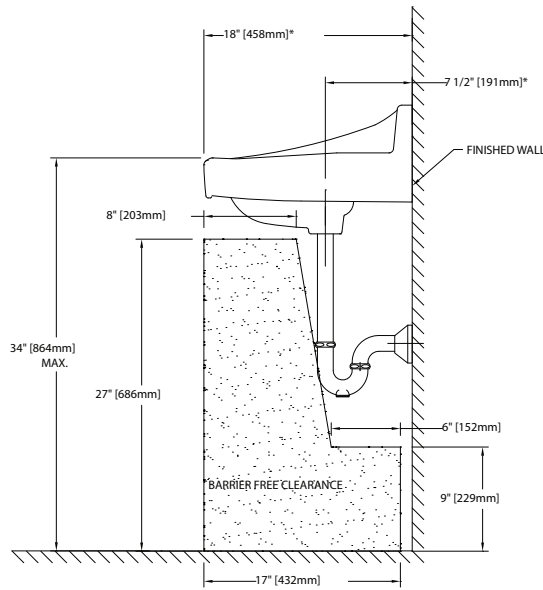

WALL HANGAR

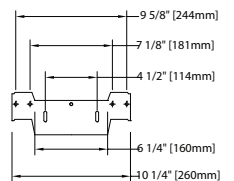

LT307.4

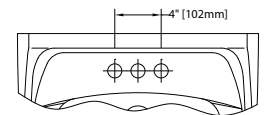

LT307.8

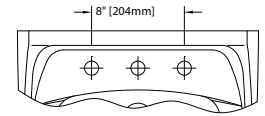

LT307A

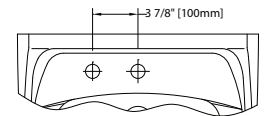

TOTO

These dimensions and specifications are subject to change without notice