

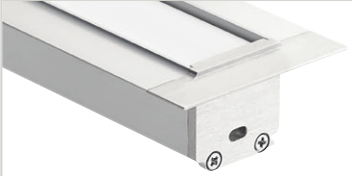
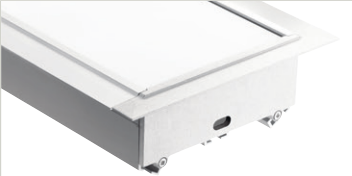
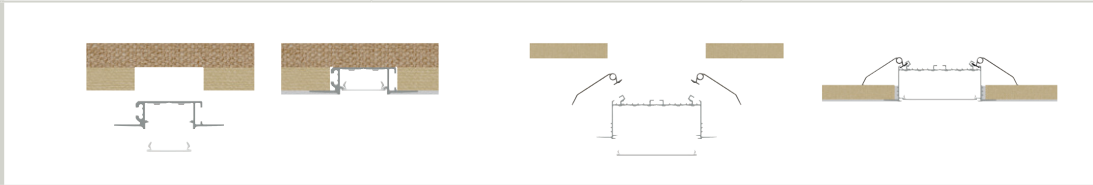
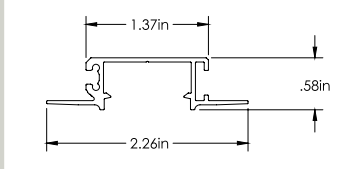
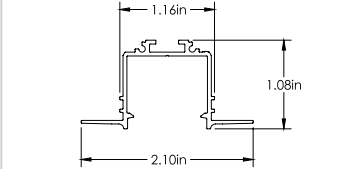
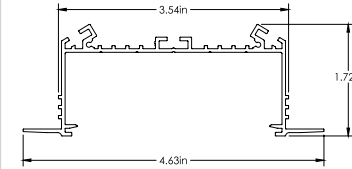

TE Pro Series

In-Wall Mud-In

1TEC2SMRC8SIL/1TEC2DMRC8SIL/
1TEC6EMRC8SIL

PROJECT:	PRODUCT #:
TYPE:	COMMENTS:
PREPARED BY:	

In-Wall Mud-In			
	Standard	Deep	Extra Wide / Deep
Channel			
Installation View			
Tape Capacity	• Utilizes two strips of LED Tape		• Utilizes six strips of LED Tape
Description	<p>Recessed into wall or ceiling - more of an architectural accent than a true source of light. Grooves along each side and under the flange allow for adhesive or construction cement to ensure a secure installation. Mounting spring clips secure to drywall. Wide flanges allow channel to be mudded and disappear into drywall applications to create a minimalistic look.</p>		
	<p>Ideal for: Incorporating light as a modern architectural accent into a ceiling or wall.</p>	<p>Ideal for: Wall and ceiling architectural accents where the deep well is utilized to create a more uniform dispersion of light.</p>	<p>Ideal for: Creating thin, recessed troffer-like fixtures of varying lengths (utilize connector brackets to elongate, or trim to shorten).</p>
Dimensions			
A La Carte To Build A Channel			
Channels 8ft	1TEC2SMRC8SIL	1TEC2DMRC8SIL	1TEC6EMRC8SIL
Lenses 8ft	1TEL0028WHO 2-Tape Wide Flat Lens, White Opaque		1TEL0068WHO 6-Tape Wide Flat Lens, White Opaque
End Caps 2 Total	1TEE2SMRCSSIL Metal with Wiring Hole	1TEE2DMRCSSIL Metal with Wiring Hole	1TEE6EMRCSSIL Metal with Wiring Hole
Mounting Clips 10 Total	-		1TEMSC1RC Spring Clip
Accessories	<p>1TEA090VCONN 90° Vertical Connector Bracket</p> <p>1TEA090HCONN 90° Horizontal Connector Bracket</p> <p>1TEA120HCONN 120° Horizontal Connector Bracket</p> <p>1TEA180HCONN Straight Connector Bracket</p>		

Compatible with Kichler Standard Output (1.5W/ft) and High Output (3W/ft) LED Tape Light.

TE Pro Series

In-Wall Mud-In

1TEC2SMRC8SIL/1TEC2DMRC8SIL/1TEC6EMRC8SIL



EXPLODED VIEW

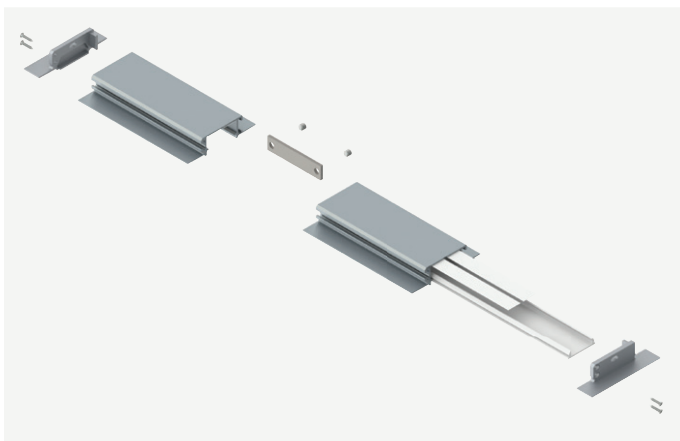

INSTALLATION VIEW

