	ITEM #:	45330/1
	UPC	748119099828
	Description	Urban Form 1-Light Mini Pendant in Black Nickel with Natural Concrete Shade
	Finish	Black Nickel
	Materials	Concrete, Metal
	Brand	ELK Lighting
	Collection	Urban Form
	Category	Indoor Lighting
	Type	Mini Pendant

ITEM DIMENSIONS				RATINGS & SPECIFICATIONS				
Width	5 inches			Safety Rating	UL		Certification	N/A
Depth	5 inches			ADA Compliant	N/A		Voltage	N/A
Height	6 inches			BULBS / SOCKETS				
Weight	4 pounds			Quantity	1	Wattage	60 watts	
ADDITIONAL DIMENSIONS				Included	No		Type	A19 (E26 Medium Base)
Backplate / Canopy	N/A			Other	N/A			
HCWO	N/A			CHAIN / CORD INFORMATION				
Min. Extension	N/A			Chain	N/A		Cord	N/A
Max. Extension	N/A			SHADE / GLASS DETAILS				
OVERALL HEIGHT				Shade/Glass Description	Natural Concrete			
Min.	N/A		Max.	N/A				
EXTENSION ROD(S)				Width	N/A		Height	N/A
N/A				Width at Top	N/A		Width at Bottom	N/A

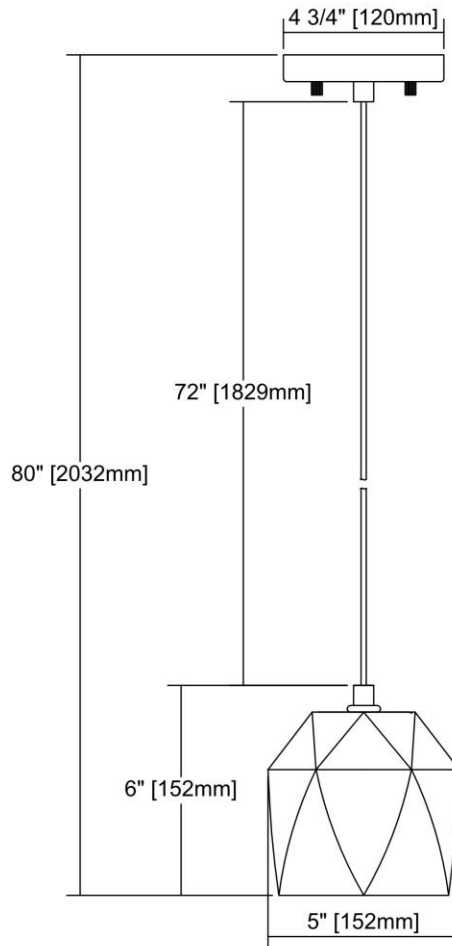

Rev. 5/9/2019