



ELEGANT

FURNITURE & LIGHTING™

## Installation manual for:

2801G96

Dimensions: D72" H96" L84

Collection: Maria Theresa

Bulb Type: E12 bulb not included

Lamp Frame Weight (lbs): 187.5

Total Weight (lbs): 350



Thank you for choosing our product(s).

Our Company is actively involved in every step of the production.

Our product(s) are designed to be utilized for every application that graces your home or business.

We pride ourselves in providing the most prompt and courtesy service to all of the valued customers.

Please find the enclosed detailed instruction and read carefully for proper installation.

If you have any questions, please contact the retailer where the purchased was made.

### SAFETY

Warning: MAKE SURE THE ELECTRICITY TO THE WIRES YOU ARE WORKING ON IS SHUT OFF. BY EITHER REMOVING THE FUSE OR TURNING OFF THE CIRCUIT BREAKER.

### CAUTION

- Before assembling the lighting fixture, please read all instructions carefully.
- All frame & crystal components are fragile, please handle with care.
- Required supply circuit : 110 - 130V/60Hz
- Labeled wires are "L" for live wire, "N" for neutral wire, "E" for ground wire.
- Never install fixture on damp ceiling, the room should be dry and well ventilated
- All electrical components must be installed by a licensed electrician and in accordance with the National Electrical Code and the appropriate local electrical codes.

### Unpack the Package

Please open the box carefully and check all the items are inside the box. If you have any installation, assembling and missing parts questions, where you purchase from and any other relevant information ready, our customer service team will provide comprehensive and worry free service to our valued customers.

## Frame Parts List

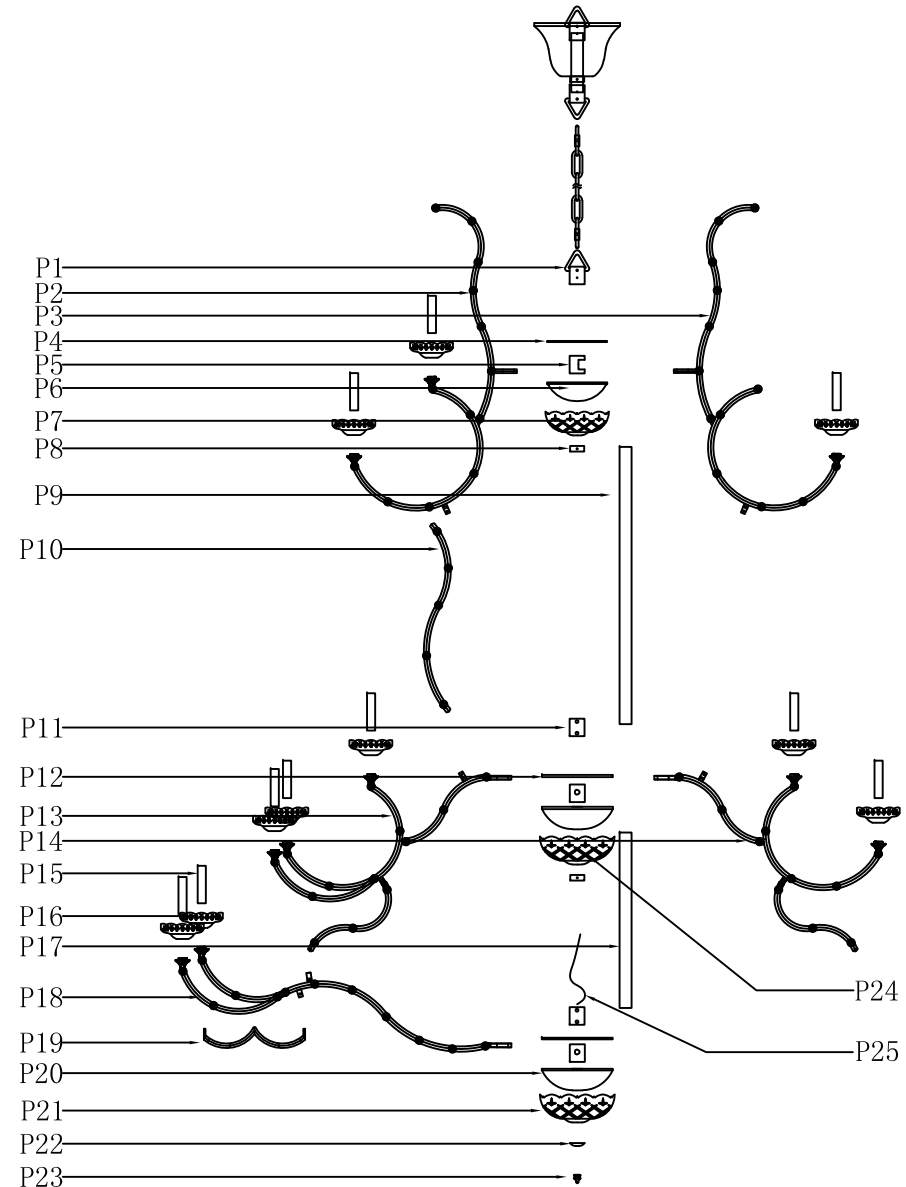











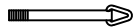



## Step 1





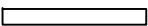











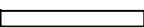
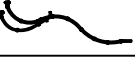

Please use the parts list to ensure you are not missing any parts

2803G96

## PARTS LIST

part	picture	Description	Parts Number	Qty	Check list
ZA		4"Crossbar	CP1032R90	1	
ZB		ø9"Canopy		1	
ZC		Canopy ring		1	
ZD		ROD1032	ROD1032	1	
ZE		L59"Chain08P Plain Design	Chain08P	1	
ZF		Power Cord 12' SPT-2-16# Clear/Gold		1	
P1		Loop		1	
P2		glass arm 33"		7	
P3		glass arm 33"		7	
P4		6.3" Metal plate		1	
P5		Hickey		2	
P6		6.3"Metal bowl		1	
P7		7"Glass dish	GD1007A70CL GD1007A70GT	1	
P8		Metal ring		2	
P9		32.5"Both end threaded pipe		1	
P10		Glass arm 20" connection	ARM10280020C ARM10280020G ARM10280020GT	14	

03

part	picture	Description	Parts Number	Qty	Check list
P11		Coupling		2	
P12		7.5"Metal plate		2	
P13		Glass arm 24"	ARM102800A24C ARM102800A24G ARM102800A24GT	7	
P14		Glass arm 24"	ARM10280024C ARM10280024G ARM10280024GT	7	
P15		4"Metal tube		84	
P16		4.5"Glass dish	GD1003G45CL GD1003G45GT	84	
P17		22.2"Both end threaded pipe		1	
P18		Glass arm 33"	ARM10280033C ARM10280033G ARM10280033GT	14	
P19		Glass arm 11" connection	ARM10280011C ARM10280011G ARM10280011GT	14	
P20		7.5"Metal bowl		2	
P21		7.8"Glass dish	GD1007A78CL GD1007A78GT	2	
P22		washer		1	
P23		Finial		1	
P24		7.8"Glass dish	GD1007F78CL GD1007F78GT	1	
P25		Steel wire		1	
A		1050-14#*3+930-3.0"		14	
B		1050-14#*1+930-2.0"		420	
C		1050-14#*1+930-3.0"		14	
D		1050-14#*14+930-3.0"		14	

04



## step 2

## Canopy Installation Instruction

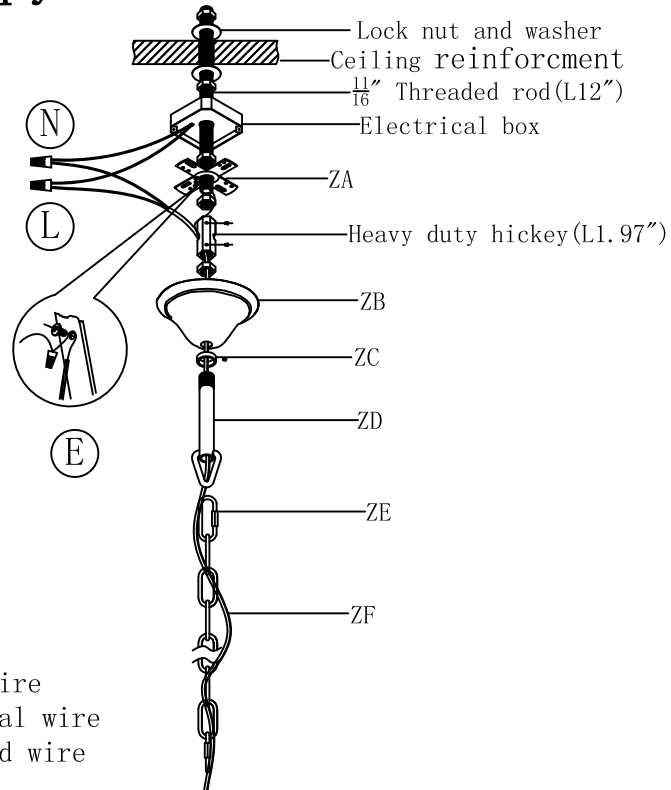

"L" = Hot wire  
 "N" = Neutral wire  
 "E" = Ground wire

IMPORTANT: Test sockets with bulb before dressing the fixture.

1. Drill a  $\phi 0.7$ " hole in the ceiling reinforcement to allow a  $\frac{1}{16}$ " threaded rod to pass through.
2. Attach the electrical box to the ceiling reinforcement and pass the  $\frac{1}{16}$ " threaded rod through the box and secure it to the heavy duty hickey.
3. Pass the fixture wires and ground wire through the loop, canopy ring, center hole of canopy and the heavy duty hickey.
4. Pull ceiling wires down through the fixture box and make connection.
5. Screw loop only onto threaded pipe.
6. Hang the fixture on chain.
7. Secure the canopy with canopy ring.

07

## Canopy Installation Instruction

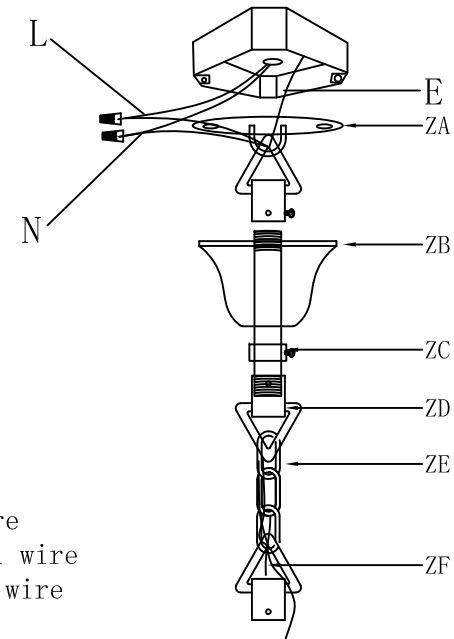

"L" = Hot wire  
 "N" = Neutral wire  
 "E" = Ground wire

Please read all instructions carefully. Before you proceed to install, make sure that the power supply is turned off and off until installation is complete. Please note that each part has been assigned a letter. Please proceed in alphabetical order.

1. Fix the crossbar(ZA) to the ceiling with the two crossbar screws.
2. Hang the Canopy ring(ZC) back up over the canopy(ZB), through metal rod(ZD) together.
3. Hang the electric main and ground wire through the chain(ZE), the Metal rod(ZD), the Loop and the crossbar(ZA) until the end of the electric main reaches the junction box where you can make the appropriate connections.
4. Be sure when connecting the wire use electrician approved junction caps.
5. Stow the excess wire in the junction box(ZA).
6. Raise the canopy(ZB).
7. Canopy ring(ZC), attach canopy(ZB) to ceiling, slide metal ring (ZC) over canopy lock(ZD) and hold the canopy(ZB).

08

# Frame Assembly Diagram

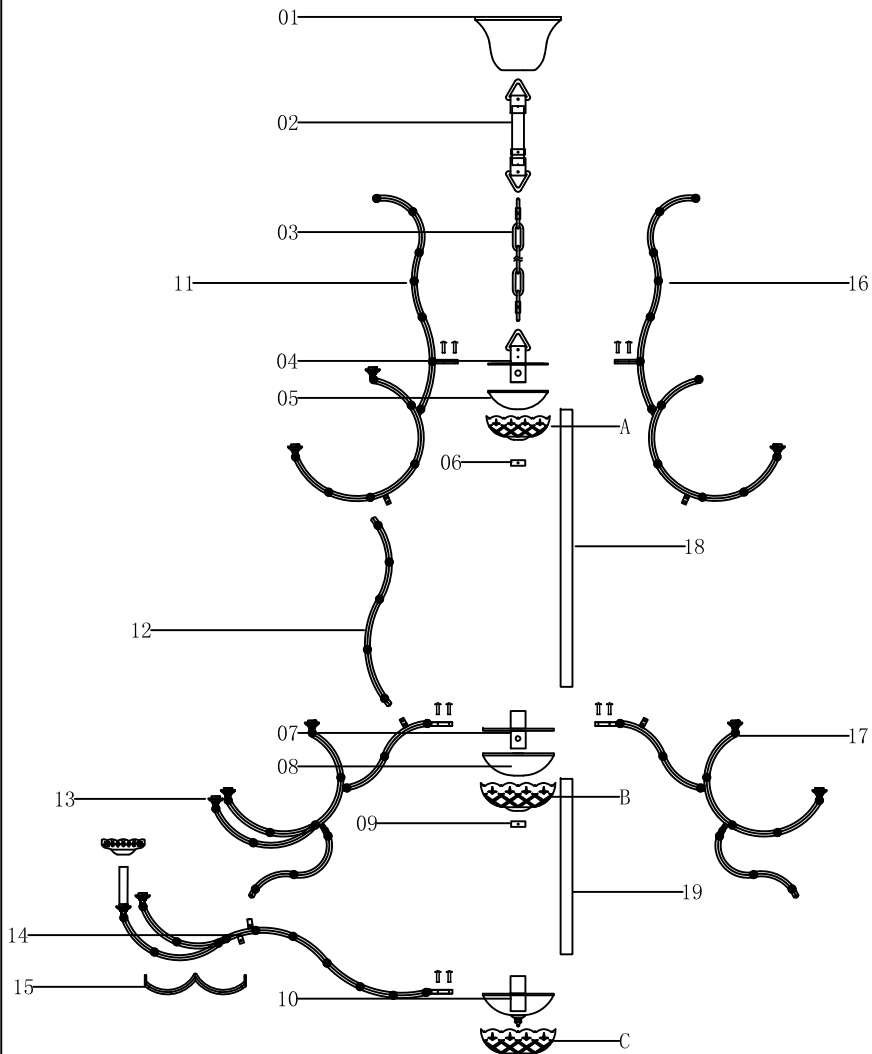

## Lamp body (10) part list

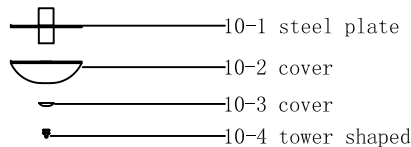

09

# Frame Assembly Instructions

## Installation:

Please read all instructions carefully.  
Before you proceed to install, make sure that the power supply is turned off and remains off until installation is complete.  
Please note that each part has been assigned a number.  
Please proceed in a numerical order.

1. Fix the crossbar to the junction to the ceiling.
2. Unscrew the threaded pipe(02) of the loop, hang the ceiling canopy(01) into the pipe(02) on the ring, then screw the pipe(02) to the heavy duty hickey.
3. Hang the chain(03) to the threaded pipe(02) the end of the loop with the safe lock.
4. Unscrew the M5screws of the steel plate(04), then assemble the lamp arm(11, 16) to the steel plate(04) and fix them with the screws, then hang the lamp body which already assembled well on the chain(03) the end of the safe lock.
5. Connect wires at the steel plate(04), then pull down the main wire though the 32" threaded pipe(18) to the end and screw the pipe(18) to the steel plate(04).
6. Hang the cover(05), 7" glass dish(A) and ring(06), in order to though the pipe(18) and fix with the ring(06).
7. Fix the steel plate(07) to the 32" threaded pipe(18). Unscrew the M5screws of the steel plate(07), then assemble the lamp arm(13, 17) to the steel plate(07) and fix them with the screws.
8. Connect the wires and the main wires at the steel plate(07) correctly, pull down the main wires though the 22" threaded pipe(19) to the end.
9. Hang the cover(08), 8" glass dish(B) and ring(19), in order to though the pipe(19) and fix with the ring(19).
10. Connect the lamp body which already assembled well with the lamp arm(12).
11. Unscrew the tower shaped(10-4), break up the parts(10-1~10-3), then fix the steel plate(10-1) to the 22" threaded pipe(19)
12. Unscrew the M5screws of the steel plate(10-1), then assemble the lamp arm(14) to the steel plate(10-1) and fix them with the screws, and connect the fixture which already assembled well to the lamp arm(13, 17), then fix the lamp arm(14) with the lamp arm(15).
13. Connect the wires at the steel plate(10-1) with the main wire correctly, then add the 8" glass dish(C) and assemble the parts(10-1~10-3) with the tower shaped(10-4).
14. Pull the main wire which already connected well, pass the chain(03) and the threaded pipe(02) to the junction box, then connect wires at the box correctly.
15. Fix the ceiling canopy(01) with the ring to the ceiling.
16. As the crystal dressing instruction, hang the crystal parts.

NOTE: The fixture have the steel wire, you can't cut it, please use the steel wire and pull up it to the canopy to fix the fixture.

10

## Step 4 Crystal Dressing Instructions

1. Hang crystal "A", "B", "C", "D", "E", "F", "G", "H", "I", "J", "K", "L", "M", "N", "O", "P", "Q", "R", "S".
2. Connect both ends of Z3 with A, Connect both ends of Z2 with C, Connect both ends of Z1 with F, Connect both ends of Z with H, Connect both ends of Y with I, Connect both ends of X with J, Connect both ends of W with K, Connect both ends of V with L, Connect both ends of U with M, Connect both ends of T with N.

## Crystal Dressing Diagram



When dressing the chandelier with the crystals please remember to wear either rubber or cotton gloves. So as to prevent any damage or smudging on the crystals.

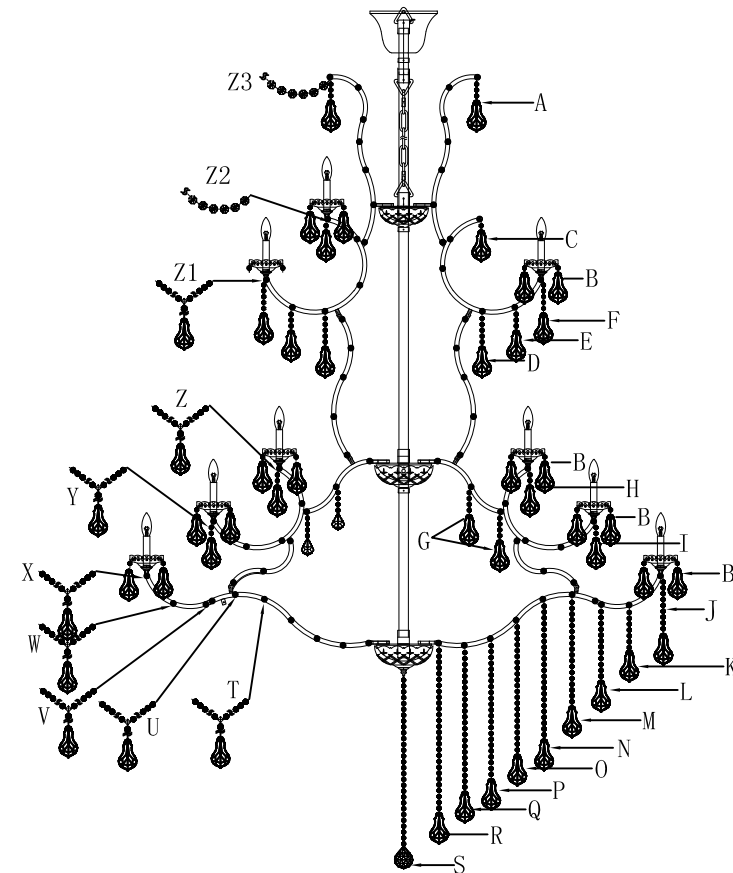

## Congratulations !

You are now done installing your Elegant Lighting fixture. Sit back and admire each crystal as it will become the statement piece for your room/house.

Thank you.

### **Cleaning and Maintenance of Chandelier Frame**

The finish on our chandelier frames and fixture frames is protected by a durable coating of lacquer. To clean, use a clean soft, dry cloth. Do not use any metal polishes, cleaners, abrasives or any substance which could remove the protective finish. Failure to follow these instructions automatically voids the guarantee.

### **Cleaning and Maintenance of Crystals**

Wet a soft cotton fabric in clean warm water and wipe gently, then polish with a dry soft cotton fabric.

### **To Order Crystal Replacement Parts**

Should you require replacement crystals or pins (the metal connectors attaching the crystals), contact the store where the product was purchased. For ease of ordering, you may use the original crystal trimming instructions provided with this product and circle the items you wish to order, indicating the quantity by writing the number needed adjacent to the circle. You will be contacted with prices prior to shipment. All orders must be pre-paid.



## Elegant Lighting Warranty

The finish and frame of your new chandelier or fixture are warranted for a period of one (1) year from the date of purchase. Our company will, at its option, repair or replace any frame that has a defect in the materials or workmanship during the warranty period. All crystals are guaranteed for their original quality during the life of the chandelier. Breakage is not covered by this warranty.

To make a claim under this warranty, contact our customer service department.

A written return authorization form will be sent to you with specific instructions.

## Returns and Conditions of Warranty

Returns must be pre-authorized by contacting the retailer where you made your purchase..Returns will only be accepted with a written return merchandise authorization and return shipping charges pre-paid. We reserve the right to inspect all returned merchandise to fully determine the nature of any defect. This guarantee shall not apply to any product that has been changed, altered or otherwise modified, nor shall it apply to any product that has been repaired or altered by anyone other than a pre-authorized facility. We will not be responsible for any breakage or damages incurred during transit, nor for crystal parts or metal frame part that have been subject to misuse, negligence, accident or inappropriate handling. Also, we will not be held responsible for damage incurred during improper installation or wiring by others, nor for damages resulting from a failure to follow the recommended maintenance or installation procedures. This guarantee is issued in lieu of any and all other guaranteed or warranty, whether written or implied and any and all other obligations or liabilities. Further, we neither authorize nor permit any other person or firm to assume for us, any liability in connection with the sale of our products.