

CRYSTORAMA

LIGHTING THE WAY FOR SIXTY YEARS

ASSEMBLY INSTRUCTION MODEL #BOL-8883-PN

WARNING



Electrical Danger



Turn Power Off

All electrical components must be installed by a licensed electrician in accordance with the National Electric Code and the appropriate local electrical codes.

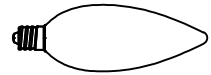

You will need 3 - Cand. Bulb
40 Watts Recommended 60 Watts Max
USE LED BULBS FOR EXTENDED USE
This fixture is DRY Rated.

How to Install

1. Secure crystals to fixture using the ball nuts.
2. Determine the desired location you'd like to put this fixture on the wall, and mark four points on it with same distance as between the holes on the Back Plate (B).
3. Drill the holes at the marked points and insert the anchors into the holes in the wall, Attach the mounting plate onto the wall by anchor screws.
4. Attach the Back Plate (B) onto mounting plate.

CRYSTAL SETS:

- a. 2"x0.8"x8.5"-1pcs
- b. 2"x0.8"x6.5"-8pcs
- c. 2"x0.8"x4.5"-4pcs

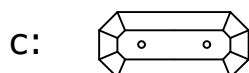
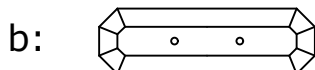
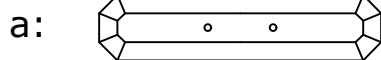
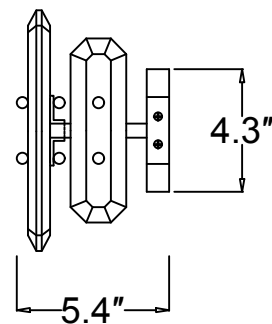
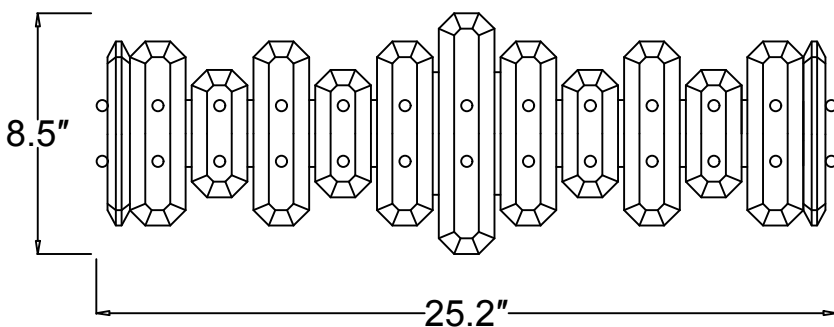
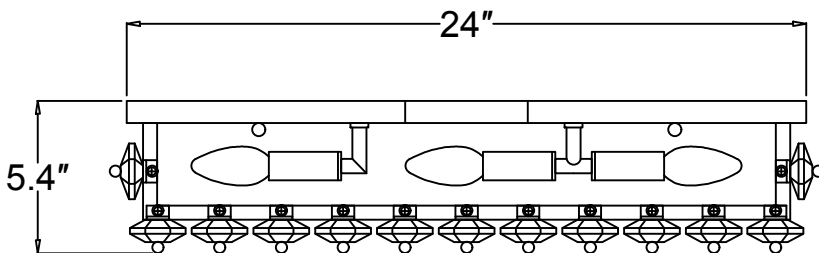

WARNING: This product can expose you to Lead, which is known to the State of California to cause cancer and/or birth defects or reproductive harm. For more information go to www.P65Warnings.ca.gov

CRYSTORAMA

LIGHTING THE WAY FOR SIXTY YEARS

PART NUMBER MODEL #BOL-8883-PN

Part Number

Part Numbers

- A. Mounting Hardware
 (1) Mounting plate
 (3) Wire nut
 (4) Mounting screw
 (4) Plastic anchors
- B. (1) Back Plate; 24"x4.3"x0.8"h; XMO8883PNBKP24IN
- C. (3) Candle Sleeve; Ø1"x2.6"h
- D. (26) Ball Nut; XMO8883PNBANUT

